



Catalog

ABB standard drives ACS310, 0.37 to 22 kW / 0.5 to 30 hp

Power and productivity
for a better world™





Two ways to select your drive

Choice 1: Simply contact your local ABB drives sales office (see page 17) and let them know what you want. Use page 3 as a reference section for more information.

OR

Choice 2: Build up your own ordering code using the simple 7-step approach below. Each step is accompanied by a reference to a page that is filled with useful information.

Type code structure:

ACS310 - 03E - 02A6 - 2 + J400

1

Product series

2

Rating and types

3

Voltages

4

Construction

5

Dimension

6

Options

7

Technical data
Control connections

8

Services

9

Contact and web information

Contents



ABB standard drives, ACS310

ABB standard drives.....4	1
Features5	
Technical specification6	
Ratings, types, voltages and construction7	2
Type code7	
Voltages7	3
Construction.....7	4
Dimensions.....8	5
Cabinet-mounted drives8	
Wall-mounted drives8	
Options8	6
How to select options8	
User interfaces9	
Machine interfaces 10	
Extension module 10	
Protection and installation 10	
FlashDrop tool 11	
SREA-01 Ethernet adapter 11	
EMC filters..... 12	
Low leakage current filters 12	
DriveWindow Light 2 13	
Technical data 14	7
Cooling and fuses 14	
Control connections 15	
Connection examples 15	
Services 16	8
www.abb.com/drives..... 17	9

ABB standard drives



ACS310 - 03E - 02A6 - 2 + J400

ABB standard drives

The ABB standard drives family has been extended with a new series dedicated drives designed for squared torque applications such as booster pumps and centrifugal fans.

The drive design includes a powerful set of features which benefit pump and fan applications including built-in PID controllers and PFC (pump and fan control) that varies the drive's performance in response to changes in pressure, flow or other external data. The drives also have pre-programmed protection functions such as pipe cleaning for preventive maintenance.

These features, combined with preprogrammed application macros, an intuitive user interface and several assistant screens, speed up the installation, parameter setting and commissioning of the drive.

Applications

- Booster pumps
- Submersible pumps
- Irrigation pumps
- Centrifugal fans

Highlights

- Pump and fan features such as pump and fan control (PFC and SPFC)
- Pipe cleaning and fill functions
- Unified height and depth
- Energy efficiency counters
- Energy optimizer
- Load Analyzer for optimized dimensioning of the drive, motor and process
- Embedded Modbus RS-485 fieldbus interface
- FlashDrop tool for fast parameter setting





ACS310 - 03E - 02A6 - 2 + J400

Feature	Advantage	Benefit
Pump and fan control (PFC) feature to control pumps and fans in parallel	<p>One drive controls several pumps or fans and eliminates the need for an external programmable logic controller.</p> <p>Reduces motor stress and increases lifetime when auxiliary motors are driven according to the needed pump/fan capacity.</p> <p>Interlock function enables one motor to be disengaged from the mains supply while others continue operating in parallel.</p>	<p>Saves cost of additional drives and external PLC.</p> <p>Longer life for pump or fan system while reducing maintenance time and costs.</p> <p>Maintenance can be carried out safely without stopping process.</p>
Soft pump and fan control feature (SPFC)	<p>Reduces unwanted pressure peaks in pumps and pipelines when an auxiliary motor is started.</p>	<p>Reduces maintenance costs.</p> <p>Longer life for pump or fan system.</p> <p>Smoother processes.</p>
Pump protection functions	<p>Integrated protection and control with pre-programmed features like pipe cleaning, pipefill, inlet/outlet pressure supervision and detection of under or over load for preventive maintenance.</p> <p>Improves process control and system reliability. Integrates system protection.</p> <p>Smoother processes: improved and optimized system. Longer life for pump and fan system, reduced maintenance costs.</p>	<p>Reduces maintenance costs.</p> <p>Longer life and reliable operation of pump system.</p>
PID controllers	<p>Varies the drive's performance according to the need of the application.</p>	<p>Enhances production output, stability and accuracy.</p>
Embedded Modbus RS-485 fieldbus interface	<p>No need for external fieldbus options.</p> <p>Integrated and compact design.</p>	<p>Saves costs of external fieldbus devices.</p> <p>Increases reliability.</p>
On/off cooling fan control	<p>Cooling fan rotates only when the drive is running, thereby cooling only when needed.</p>	<p>Silent operation.</p> <p>Improves drive's energy efficiency.</p>
Software controlled phase inversion	<p>Fast and easy way to change the phase order of the motor rotation.</p>	<p>Time savings as there is no need to change the output cable order manually.</p>
Short parameter menu view	<p>Only the most needed drive parameters are shown on the drive's parameter view. Complete parameter view can be changed by setting one parameter.</p>	<p>Time savings as user can quickly see the most important parameters.</p> <p>Fast commissioning of the drive.</p>
Energy optimizer	<p>Improved motor efficiency with intelligent drive control method, especially while operating on partial centrifugal loads.</p>	<p>Boosts energy efficiency due to lower motor currents.</p> <p>Reduces audible noise from the motor.</p>
Energy efficiency counters	<p>Several counters to illustrate saved energy (kWh), carbon-dioxide emissions (CO₂) and cost in local currency.</p>	<p>Shows direct impact on energy bill and helps control operational expenditure (OPEX).</p>
Full output current at 50 °C ambient	<p>Drive can be operated in ambient temperatures up to 50 °C without de-rating the output current.</p>	<p>Optimized drive dimensioning for wide temperature range.</p>
Load analyzer	<p>Load analyzer saves process data, such as current and torque values, which can be used to analyze the process and dimensioning of the drive and motor.</p>	<p>Optimized dimensioning of the drive, motor and process.</p>
Compact size and high power density ratio	<p>Efficient cabinet space usage.</p>	<p>Space savings.</p>
Unified height and depth	<p>Optimum installation layout.</p>	<p>Space savings.</p>
Different mounting options; screw or DIN rail mounting, sideways or side-by-side	<p>Flexible installation.</p>	<p>One drive can be used in various designs, saving installation costs and time.</p>
User interfaces	<p>Assistant control panel with clear alphanumerical dynamic menus, real time clock and 14 languages.</p> <p>Basic panel with numerical display.</p>	<p>Different control panels available according to functionality need.</p>
Maintenance assistant	<p>Monitors consumed energy (kWh), running hours or motor rotation.</p>	<p>Assists in preventive maintenance of the drive, motor or run application.</p>
Commissioning assistants	<p>Easy set up of parameters for PID controllers, real-time clock, serial communication, drive optimizer and drive start-up.</p>	<p>Time savings with reduced need to set the parameters manually.</p> <p>Ensures all required parameters are set.</p>
Drive protection	<p>Motor output and I/O protected against wiring faults.</p> <p>Protection against unstable supply networks.</p> <p>Coated boards as standard.</p>	<p>Latest solution to protect the drive and offer trouble free use and the highest quality.</p>

Technical specification



ACS310 - 03E - 02A6 - 2 + J400

Mains connection

Voltage and power range	3-phase, 200 to 240 V \pm 10% 0.37 to 11 kW (0.5 to 15 hp) 3-phase, 380 to 480 V \pm 10% 0.37 to 22 kW (0.5 to 30 hp)
Frequency	48 to 63 Hz

Motor connection

Voltage	3-phase, from 0 to U_{supply}
Frequency	0 to 500 Hz
Continuous loading capability	I_{2N} maximum continuous output current at ambient temperature of +40 °C. No overloadability, derating 1% for every additional 1 °C up to 50 °C. I_{LD} continuous output current at max ambient temperature of +50 °C. 10% overloadability for one minute every ten minutes.
Switching frequency	
Default	4 kHz
Selectable	4 to 16 kHz with 4 kHz steps
Acceleration time	0.1 to 1800 s
Deceleration time	0.1 to 1800 s

Environmental limits

Ambient temperature	-10 to 50 °C (14 to 122 °F), no frost allowed
Altitude	
Output current	Rated current available at 0 to 1000 m (0 to 3281 ft) reduced by 1% per 100 m (328 ft) over 1000 to 2000 m (3281 to 6562 ft)
Relative humidity	Lower than 95% (without condensation)
Degree of protection	IP20 / optional NEMA 1 enclosure
Enclosure colour	NCS 1502-Y, RAL 9002, PMS 420 C
Contamination levels	IEC721-3-3 No conductive dust allowed
Transportation	Class 1C2 (chemical gases) Class 1S2 (solid particles)
Storage	Class 2C2 (chemical gases) Class 2S2 (solid particles)
Operation	Class 3C2 (chemical gases) Class 3S2 (solid particles)

Product compliance

Low Voltage Directive 2006/95/EC
Machinery Directive 98/37/EC
EMC Directive 2004/108/EC
Quality assurance system ISO 9001
Environmental system ISO 14001
CE and C-Tick approvals
UL, cUL and GOST R
RoHS compliant

EMC

Class C3 (2nd environment unrestricted distribution) inbuilt as standard
Class C2 and C1 with external optional EMC filters

Programmable control connections

Two analog inputs	
Voltage signal	
Unipolar	0 (2) to 10 V, $R_{in} > 312 \text{ k}\Omega$
Bipolar	-10 to 10 V, $R_{in} > 312 \text{ k}\Omega$
Current signal	
Unipolar	0 (4) to 20 mA, $R_{in} = 100 \Omega$
Bipolar	-20 to 20 mA, $R_{in} = 100 \Omega$
Resolution	0.1%
Accuracy	$\pm 1\%$
One analog output	0 (4) to 20 mA, load $< 500 \Omega$
Auxiliary voltage	24 V DC $\pm 10\%$, max. 200 mA
Five digital inputs	12 to 24 V DC with internal or external supply, PNP and NPN, pulse train 0 to 16 kHz
Input impedance	2.4 k Ω
One relay output	
Type	NO + NC
Maximum switching voltage	250 V AC/30 V DC
Maximum switching current	0.5 A/30 V DC; 5 A/230 V AC
Maximum continuous current	2 A rms
One digital output	
Type	Transistor output
Maximum switching voltage	30 V DC
Maximum switching current	100 mA/30 V DC, short circuit
Frequency	10 Hz to 16 kHz
Resolution	1 Hz
Accuracy	0.2%
Serial communication	
Fieldbus	Modbus RS-485, embedded
Cable	Shielded twisted pair, impedance 100 to 150 ohms
Termination	Daisy-chained bus, without dropout lines
Isolation	Bus interface isolated from drive
Transfer rate	1.2 to 76.8 kbit/s
Communication type	Serial, asynchronous, half duplex
Protocol	Modbus
Chokes	
AC input chokes	External option For reducing THD in partial loads and to comply with EN/IEC 61000-3-12
AC output chokes	External option To achieve longer motor cables

Ratings, types, voltages and construction



ACS310 - 03E - 02A6 - 2 + J400

Type code

This is the unique reference number (shown above and in column 4, right) that clearly identifies your drive by power rating and frame size. Once you have selected the type code, the frame size (column 6) can be used to determine the drive dimensions, shown on the next page.

Voltages

ACS310 is available in two voltage ranges:

2 = 200 - 240 V

4 = 380 - 480 V

Insert either "2" or "4", depending on your chosen voltage, into the type code shown above.

Construction

"03E" within the type code (shown above) varies depending on the drive phase and EMC filtering. Choose below the one you need.

03 = 3-phase

E = EMC filter connected, 50 Hz frequency

U = EMC filter disconnected, 60 Hz frequency

(In case the filter is required it can easily be connected.)

Ratings				Type code	Frame size
P_N kW	P_N hp	$I_{2N}^{1)}$ A	$I_{LD}^{2)}$ A		
3-phase supply voltage 200 - 240 V units					
0.37	0.5	2.6	2.4	ACS310-03X-02A6-2	R0
0.55	0.75	3.9	3.5	ACS310-03X-03A9-2	R0
0.75	1.0	5.2	4.7	ACS310-03X-05A2-2	R1
1.1	1.5	7.4	6.7	ACS310-03X-07A4-2	R1
1.5	2.0	8.3	7.5	ACS310-03X-08A3-2	R1
2.2	3.0	10.8	9.8	ACS310-03X-10A8-2	R2
3.0	4.0	14.6	13.3	ACS310-03X-14A6-2	R2
4.0	5.0	19.4	17.6	ACS310-03X-19A4-2	R2
5.5	7.5	26.8	24.4	ACS310-03X-26A8-2	R3
7.5	10.0	34.1	31.0	ACS310-03X-34A1-2	R4
11.0	15.0	50.8	46.2	ACS310-03X-50A8-2	R4
3-phase supply voltage 380 - 480 V units					
0.37	0.5	1.3	1.2	ACS310-03X-01A3-4	R0
0.55	0.75	2.1	1.9	ACS310-03X-02A1-4	R0
0.75	1.0	2.6	2.4	ACS310-03X-02A6-4	R1
1.1	1.5	3.6	3.3	ACS310-03X-03A6-4	R1
1.5	2.0	4.5	4.1	ACS310-03X-04A5-4	R1
2.2	3.0	6.2	5.6	ACS310-03X-06A2-4	R1
3.0	4.0	8.0	7.3	ACS310-03X-08A0-4	R1
4.0	5.0	9.7	8.8	ACS310-03X-09A7-4	R1
5.5	7.5	13.8	12.5	ACS310-03X-13A8-4	R3
7.5	10.0	17.2	15.6	ACS310-03X-17A2-4	R3
11.0	15.0	25.4	23.1	ACS310-03X-25A4-4	R3
15.0	20.0	34.1	31	ACS310-03X-34A1-4	R4
18.5	25.0	41.8	38	ACS310-03X-41A8-4	R4
22.0	30.0	48.4	44	ACS310-03X-48A4-4	R4

X within the type code stands for E or U.

¹⁾ I_{2N} maximum continuous output current at ambient temperature of +40 °C. No overloadability, derating 1% for every additional 1 °C up to 50 °C.

²⁾ I_{LD} continuous output current at max ambient temperature of +50 °C. 10% overloadability for one minute every ten minutes.



Dimensions

ACS310 - 03E - 02A6 - 2 + J400

Cabinet-mounted drives (IP20 UL open)

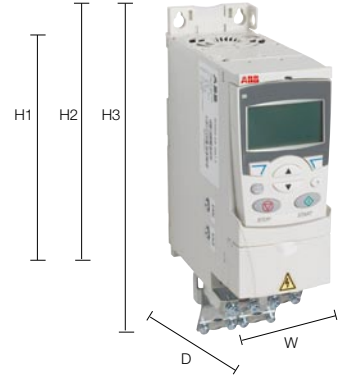

Wall-mounted drives (NEMA 1)

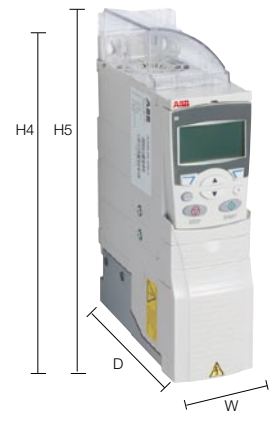

Frame size	IP20 UL open						NEMA 1				
	H1 mm	H2 mm	H3 mm	W mm	D mm	Weight kg	H4 mm	H5 mm	W mm	D mm	Weight kg
R0	169	202	239	70	161	1.1	257	280	70	169	1.5
R1	169	202	239	70	161	1.3	257	280	70	169	1.7
R2	169	202	239	105	165	1.5	257	282	105	169	1.9
R3	169	202	236	169	169	2.9	260	299	169	177	3.5
R4	181	202	244	260	169	4.4	270	320	260	177	5.0

H1 = Height without fastenings and clamping plate
H2 = Height with fastenings but without clamping plate
H3 = Height with fastenings and clamping plate
H4 = Height with fastenings and NEMA 1 connection box
H5 = Height with fastenings, NEMA 1 connection box and hood
W = Width
D = Depth

Options

ACS310 - 03E - 02A6 - 2 + J400

How to select options

The options shown in the table are available within the ACS310 range. The control panels have an associated 4-figure option code, which is shown in the second column. It is this code that replaces J400 in the type code above.

Options	Ordering code	Description	Model
Protection class	*)	NEMA 1 (R0, R1, R2)	MUL1-R1
	*)	NEMA 1 (R3)	MUL1-R3
	*)	NEMA 1 (R4)	MUL1-R4
Control panel	J400	Assistant control panel	ACS-CP-A ²⁾
	J404	Basic control panel	ACS-CP-C ¹⁾
Panel mounting kit	*)	Panel mounting kit	ACS/H-CP-EXT
	*)	Panel holder mounting kit	OPMP-01
Extension module	*)	Relay output extension module	MREL-01
Tools	*)	FlashDrop tool	MFDT-01
	*)	DriveWindow Light 2	DriveWindow Light 2
External options	*)	Input chokes	
	*)	EMC filters	
	*)	Output chokes	
Remote monitoring	*)	Ethernet adapter	SREA-01

*) = Ordering with a separate MRP code number.
¹⁾ The ACS310 is compatible with ACS-CP-C basic control panel Rev M or later.
²⁾ The ACS310 is compatible with ACS-CP-A assistant control panel Rev E or later.
(New panel series manufactured since 2007 with serial number XXXWWRXXXX, where year Y = 7 or greater and revision R = E, F, G, ...)



ACS310 - 03E - 02A6 - 2 + J400



Panel cover
(included as standard)



Basic control panel



Assistant control panel



Panel mounting kits

User interfaces

Panel cover

The purpose of the panel cover is to protect the drive's connection surfaces. The ACS310 drive is delivered with a panel cover as standard. In addition there are two alternative control panels available as options.

Basic control panel

The basic control panel features a single line numeric display. The panel can be used to control the drive, set parameter values or copy them from one drive to another.

Assistant control panel

The assistant control panel features a multilingual alphanumeric display for easy drive programming. The control panel has various assistants and an inbuilt help function to guide the user. It includes a real time clock, which can be used during fault logging and in controlling the drive, such as start/stop. The control panel can be used for copying parameters for back up or for downloading to another drive. A large graphical display and soft keys make it extremely easy to navigate.

Panel mounting kits

To attach the control panel to the outside of a larger enclosure, two panel mounting kits are available. A simple and cost-efficient installation is possible with the ACS/H-CP-EXT kit, while the OPMP-01 kit provides a more user-friendly solution, including a panel platform that enables the panel to be removed in the same way as a drive-mounted panel. The panel mounting kits include all hardware required, including 3 m extension cables and installation instructions.

Options Interfaces



ACS310 - 03E - 02A6 - 2 + J400

Machine interfaces

The embedded Modbus RS-485 fieldbus brings connectivity to major automation systems. A single twisted pair cable avoids large amounts of conventional cabling, thereby reducing costs and increasing system reliability.

Extension module

MREL-01
ACS310 has one relay output as standard. The optional MREL-01 module offers three additional relay outputs. The outputs can be configured for different functions by setting selected parameters.

Protection and installation

NEMA 1 kit
The NEMA 1 kit includes a connection box for finger protection, conduit tube installation, and a hood for protection against dirt and dust.

Terminal cover
The terminal cover is for protection of the I/O connections.

Clamping plates
The clamping plates are used for protection against electrical disturbances. The clamping plates with the clamps are included in the drive package as standard.

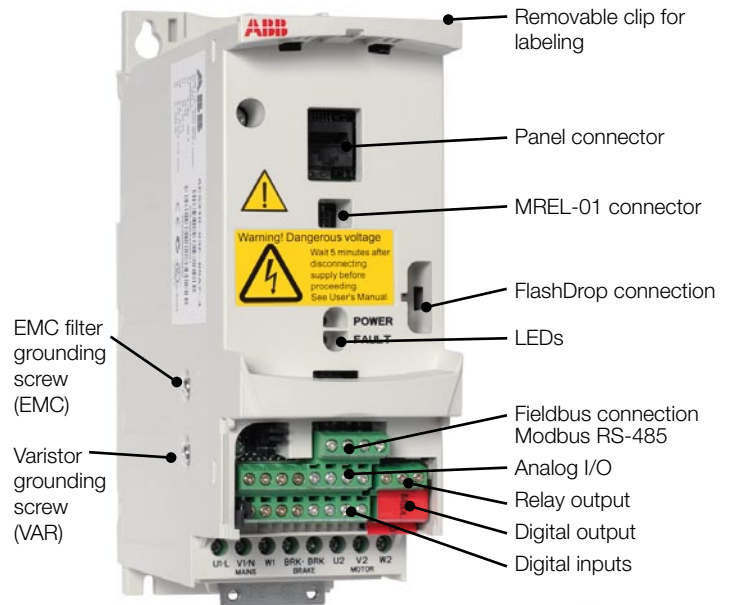



Options

External

A separate order line and type code is required for any of these external options.

FlashDrop tool

FlashDrop is a powerful palm sized tool for fast and easy parameter selecting and setting. It gives the possibility to hide selected parameters to protect the machine. Only the parameters needed in the application are shown. The tool can copy parameters between two drives or between a PC and a drive. All the above can be done without a power connection to the drive – in fact, it is not even necessary to unpack the drive.

DrivePM

DrivePM (Drive parameter manager) is a tool to create, edit and copy parameter sets for FlashDrop. For each parameter/group the user has a possibility to hide it, which means that the drive user does not see the parameter/group at all. DrivePM version 1.2 is compatible with ACS310 drives.

DrivePM requirements

- Windows 2000/XP/Vista
- Free serial port from a PC

FlashDrop package includes

- FlashDrop tool
- DrivePM software on a CD-rom
- User's manual in English and in pdf-format on the CD-rom
- Cable OPCA-02 for connection between the PC and FlashDrop tool
- Battery charger



SREA-01 Ethernet adapter

SREA-01 Ethernet adapter with remote monitoring access can send process data, data logs and event messages independently, without a PLC or a dedicated on-site computer. It has an internal web server for configuration and drive access.



Options

External



A separate order line and type code is required for any of these external options.

EMC filters

The ACS310's internal EMC filter is designed to meet category C3 requirements of EN/IEC 61800-3 standard. External EMC filters are used to enhance the drives electromagnetic performance in conjunction with its internal filtering. Maximum motor cable length depends on required electromagnetic performance, according to the table below.

Type code ACS310-	Frame size	Filter type	Cable length with EMC filter			Cable length without EMC filter	
			C1 [m]	C2 [m]	C3 [m]	C3 [m]	C4 [m]
3-phase supply voltage 200 - 240 V units							
03X-02A6-2	R0	RFI-32	10	30	-	30	30
03X-03A9-2	R0	RFI-32	10	30	-	30	30
03X-05A2-2	R1	RFI-32	10	30	50	30	50
03X-07A4-2	R1	RFI-32	10	30	50	30	50
03X-08A3-2	R1	RFI-32	10	30	50	30	50
03X-10A8-2	R2	RFI-32	10	30	50	30	50
03X-14A6-2	R2	RFI-33	10	30	50	30	50
03X-19A4-2	R2	RFI-33	10	30	50	30	50
03X-26A8-2	R3	RFI-34	10	30	50	30	50
03X-34A1-2	R4	RFI-34	10	30	50	30	50
03X-50A8-2	R4	RFI-34	10	30	50	30	50
3-phase supply voltage 380 - 480 V units							
03X-01A3-4	R0	RFI-32	30	30	-	30	30
03X-02A1-4	R0	RFI-32	30	30	-	30	30
03X-02A6-4	R1	RFI-32	50	50	50	30	50
03X-03A6-4	R1	RFI-32	50	50	50	30	50
03X-04A5-4	R1	RFI-32	50	50	50	30	50
03X-06A2-4	R1	RFI-32	50	50	50	30	50
03X-08A0-4	R1	RFI-32	50	50	50	30	50
03X-09A7-4	R1	RFI-32	50	50	50	30	50
03X-13A8-4	R3	RFI-33	40	40	40	30	50
03X-17A2-4	R3	RFI-33	40	40	40	30	50
03X-25A4-4	R3	RFI-33	40	40	40	30	50
03X-34A1-4	R4	RFI-34	-	30	-	30	50
03X-41A8-4	R4	RFI-34	-	30	-	30	50
03X-48A4-4	R4	RFI-34	-	30	-	30	50

Low leakage current filters

Low leakage current filters are ideal for installations where residual current devices (RCD) are required and leakage current needs to be below 30 mA.

Type code ACS310-	Frame size	Filter type	Cable length ¹⁾ with LRFI filter
			C2 [m]
Low leakage current filters, 3-phase supply voltage 400 V units			
03X-01A3-4	R0	LRFI-31	10
03X-02A1-4	R0	LRFI-31	10
03X-02A6-4	R1	LRFI-31	10
03X-03A6-4	R1	LRFI-31	10
03X-04A5-4	R1	LRFI-31	10
03X-06A2-4	R1	LRFI-31	10
03X-08A0-4	R1	LRFI-32	10
03X-09A7-4	R1	LRFI-32	10

¹⁾ Internal EMC filter must be disconnected by removing the EMC screw from the drive.

EMC standards in general

EN 61800-3 (2004), product standard	EN 55011, product family standard for industrial, scientific and medical (ISM) equipment	EN 61800-3/A11 (2000), product standard
Category C1	Group 1 Class B	1 st environment, unrestricted distribution
Category C2	Group 1 Class A	1 st environment, restricted distribution
Category C3	Group 2 Class A	2 nd environment, unrestricted distribution
Category C4	Not applicable	2 nd environment, restricted distribution



Options

Software tools

A separate order line and type code is required for any of these software tool options.

DriveWindow Light 2

DriveWindow Light 2 is an easy-to-use start-up and maintenance tool for ACS310 drives. It can be used in an offline mode, which enables parameter setting at the office even before going to the actual site. The parameter browser enables viewing, editing and saving of parameters. The parameter comparison feature makes it possible to compare parameter values between the drive and saved parameter files. With the parameter subset you can create your own parameter sets. Controlling the drive is one of the features in DriveWindow Light. With this software tool, you can monitor up to four signals simultaneously. This can be done in both graphical and numerical format. DriveWindow Light 2 version 2.9 or later is compatible with ACS310 drives.

Start-up wizards

Start-up wizards make the setting of parameters easy. Simply launch the wizard, select an appropriate assistant e.g. for setting analog outputs, and all parameters related to this function are shown together with help pictures.

Highlights

- Editing, saving and downloading parameters
- Graphical and numerical signal monitoring
- Drive control
- Start-up wizards

DriveWindow Light requirements

- Windows NT/2000/XP/Vista
- Free serial port from a PC
- Free control panel connector

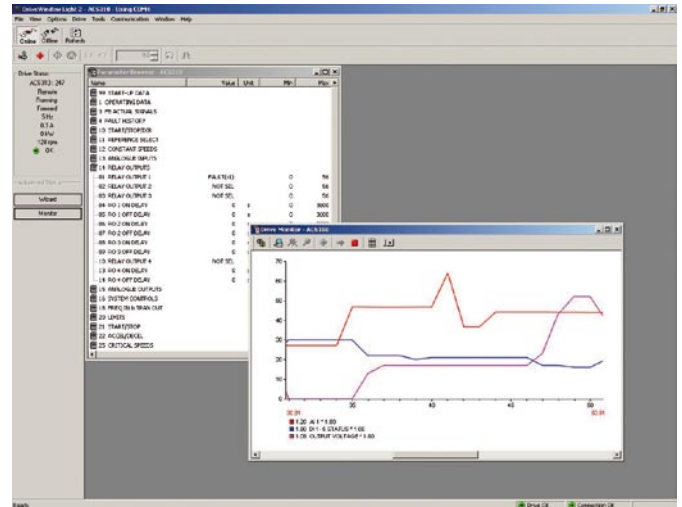

Technical data



Cooling

ACS310 is fitted with cooling fans as standard. The cooling air must be free from corrosive substances and must not be above the maximum ambient temperature of 50 °C. For more specific limits see the Technical specification - Environmental limits in this catalogue.

Cooling air flow

Type code	Frame size	Heat dissipation		Air flow	
		w	BTU/Hr	m ³ /h	ft ³ /min
3-phase supply voltage 200 - 240 V units					
ACS310-03X-02A6-2	R0	42	142	-*)	-*)
ACS310-03X-03A9-2	R0	54	183	-*)	-*)
ACS310-03X-05A2-2	R1	64	220	24	14
ACS310-03X-07A4-2	R1	86	295	24	14
ACS310-03X-08A3-2	R1	88	302	21	12
ACS310-03X-10A8-2	R2	111	377	21	12
ACS310-03X-14A6-2	R2	140	476	52	31
ACS310-03X-19A4-2	R2	180	613	52	31
ACS310-03X-26A8-2	R3	285	975	71	42
ACS310-03X-34A1-2	R4	328	1119	96	57
ACS310-03X-50A8-2	R4	488	1666	96	57
3-phase supply voltage 380 - 480 V units					
ACS310-03X-01A3-4	R0	35	121	-*)	-*)
ACS310-03X-02A1-4	R0	40	138	-*)	-*)
ACS310-03X-02A6-4	R1	50	170	13	8
ACS310-03X-03A6-4	R1	60	204	13	8
ACS310-03X-04A5-4	R1	69	235	13	8
ACS310-03X-06A2-4	R1	90	306	19	11
ACS310-03X-08A0-4	R1	107	364	24	14
ACS310-03X-09A7-4	R1	127	433	24	14
ACS310-03X-13A8-4	R3	161	551	52	31
ACS310-03X-17A2-4	R3	204	697	52	31
ACS310-03X-25A4-4	R3	301	1029	71	42
ACS310-03X-34A1-4	R4	408	1393	96	57
ACS310-03X-41A8-4	R4	498	1700	96	57
ACS310-03X-48A4-4	R4	588	2007	96	57

X within the type code stands for E or U.

*) Frame size R0 with free convection cooling.

Fuses

Standard fuses can be used with ABB standard drives. For input fuse connections see table below.

Selection table

Type code	Frame size	IEC Fuses		UL Fuses	
		A	Fuse type*)	A	Fuse type*)
3-phase supply voltage 200 - 240 V units					
ACS310-03X-02A6-2	R0	10	gG	10	UL class T
ACS310-03X-03A9-2	R0	10	gG	10	UL class T
ACS310-03X-05A2-2	R1	10	gG	15	UL class T
ACS310-03X-07A4-2	R1	16	gG	15	UL class T
ACS310-03X-08A3-2	R1	16	gG	15	UL class T
ACS310-03X-10A8-2	R2	16	gG	20	UL class T
ACS310-03X-14A6-2	R2	25	gG	30	UL class T
ACS310-03X-19A4-2	R2	25	gG	35	UL class T
ACS310-03X-26A8-2	R3	63	gG	60	UL class T
ACS310-03X-34A1-2	R4	80	gG	80	UL class T
ACS310-03X-50A8-2	R4	100	gG	100	UL class T
3-phase supply voltage 380 - 480 V units					
ACS310-03X-01A3-4	R0	10	gG	10	UL class T
ACS310-03X-02A1-4	R0	10	gG	10	UL class T
ACS310-03X-02A6-4	R1	10	gG	10	UL class T
ACS310-03X-03A6-4	R1	10	gG	10	UL class T
ACS310-03X-04A5-4	R1	16	gG	15	UL class T
ACS310-03X-06A2-4	R1	16	gG	15	UL class T
ACS310-03X-08A0-4	R1	16	gG	20	UL class T
ACS310-03X-09A7-4	R1	20	gG	25	UL class T
ACS310-03X-13A8-4	R3	25	gG	30	UL class T
ACS310-03X-17A2-4	R3	35	gG	35	UL class T
ACS310-03X-25A4-4	R3	50	gG	50	UL class T
ACS310-03X-34A1-4	R4	80	gG	80	UL class T
ACS310-03X-41A8-4	R4	100	gG	100	UL class T
ACS310-03X-48A4-4	R4	100	gG	100	UL class T

X within the type code stands for E or U.

*) According to IEC-60269 standard.

Free space requirements

Enclosure type	Space above mm	Space below mm	Space on left/right mm
All frame sizes	75	75	0

Control connections



The diagram below gives an overview of ACS310 control connections. Please refer to the ACS310 User's Manual for more detailed information.

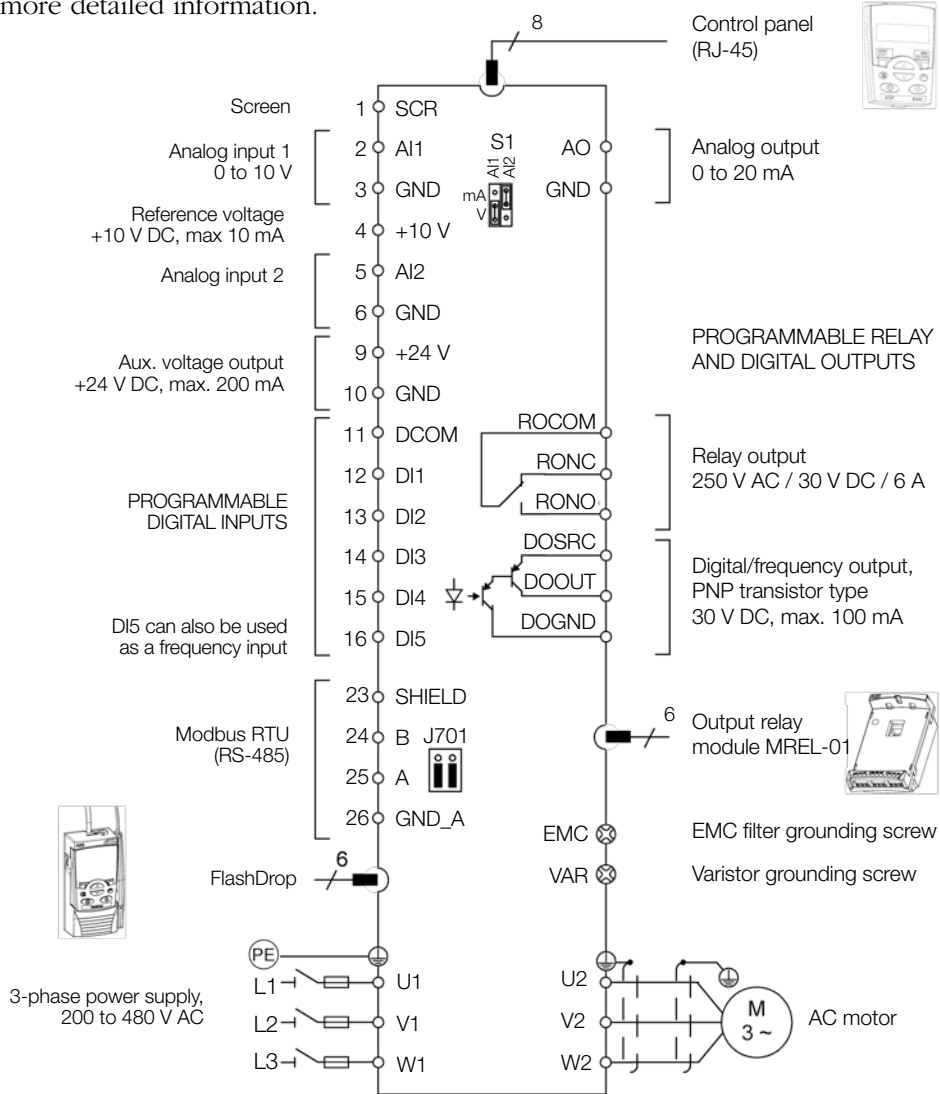

DI configuration NPN connected (sink)

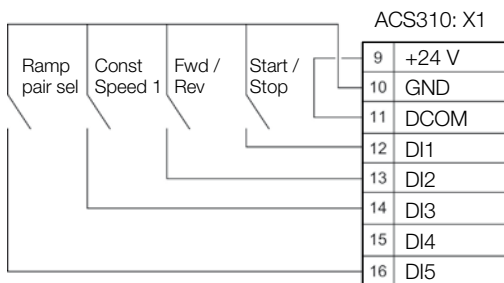

DI configuration PNP connected (source) with external power supply

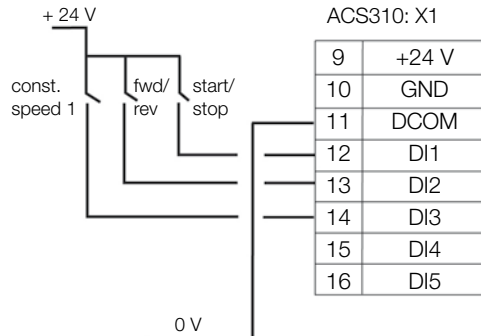

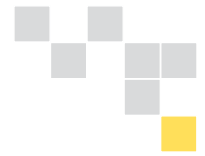

All industries face a common goal: to maximize their production output at the lowest possible cost, while maintaining the highest quality end products. One of ABB's key objectives is to maximize the uptime of its customers' processes by ensuring optimum lifetime of all ABB products in a predictable, safe and low cost manner.

The services offered for ABB low voltage drives span the entire value chain, from the moment a customer makes the first enquiry through to disposal and recycling of the drive. Throughout the value chain, ABB provides training and learning, technical support and contracts. All of this is supported by one of the most extensive global drive sales and service networks.

Maximizing return on investment

At the heart of ABB's services is its drive lifecycle management model. All services available for ABB low voltage drives are planned according to this model. For customers it is easy to see which services are available at which phase.

precisely the timing of the part replacements plus all other maintenance related actions. The model also helps the customer when deciding about upgrades, retrofits and replacements.

Drive specific maintenance schedules are also based on this four-phase model. Thus, a customer knows

Professional management of the drive's lifecycle maximizes the return on any investment in ABB low voltage drives.

ABB drive lifecycle management model



ABB follows a four-phase model for managing drive lifecycles, which brings enhanced customer support and improved efficiency.

Examples of lifecycle services are: selection and dimensioning, installation and commissioning, preventive and corrective maintenance, remote services, spare part services, training and learning, technical support, upgrade and retrofit, replacement and recycling.

Contact and web information

www.abb.com/drives

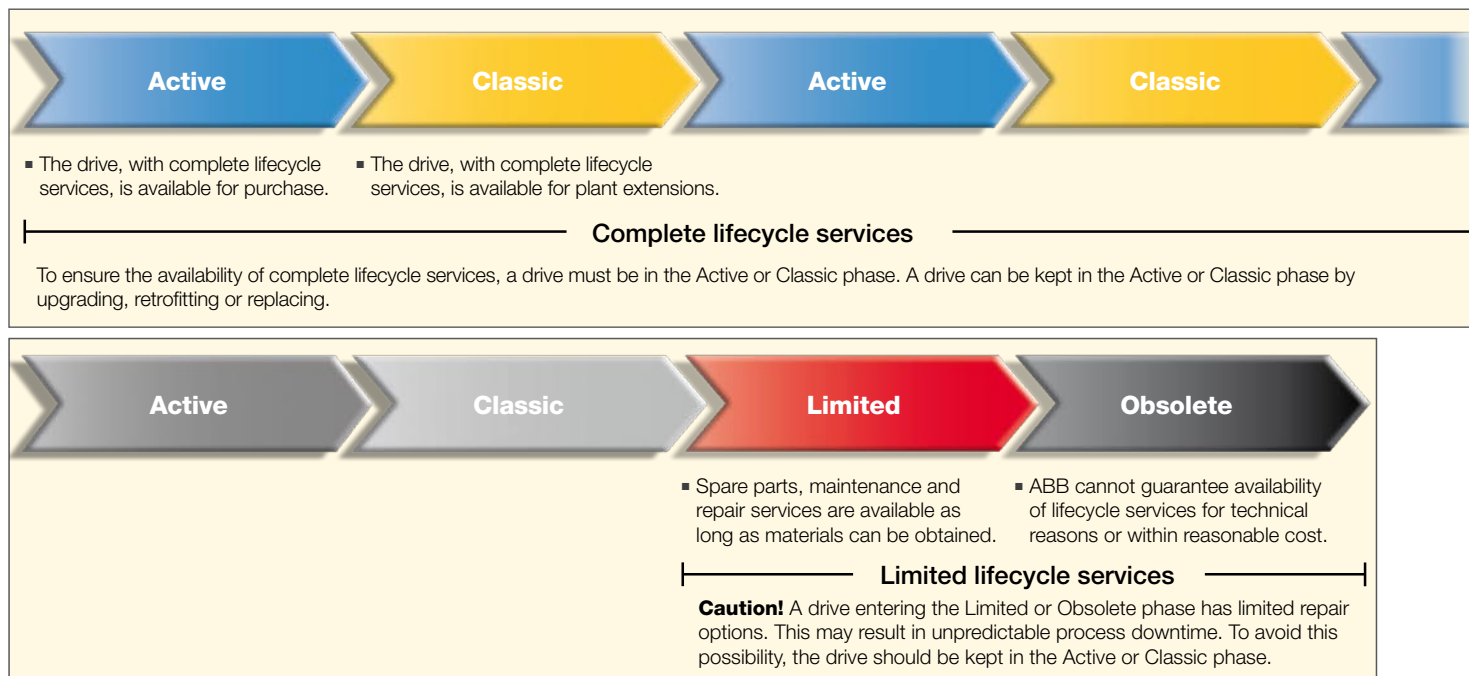

ABB's worldwide presence is built on strong local companies working together with the channel partner network. By combining the experience and know-how gained in local and global markets, we ensure that our customers in all industries can gain the full benefit from our products.

For further details about all our low voltage AC drives and services please contact your nearest ABB office or ABB drives channel partner or visit the websites www.abb.com/drives and www.abb.com/drivespartners.

Albania (Tirana)

Tel: +355 42 241 492
Fax: +355 42 234 368

Algeria

Tel: +213 21 553 860
Fax: +213 21 552 330

Argentina (Valentin Alsina)

Tel: +54 11 4229 5500
Fax: +54 11 4229 5784

Australia (Victoria - Notting Hill)

Tel: +1800 222 435
Tel: +61 3 8544 0000
e-mail: drives@au.abb.com

Austria (Vienna)

Tel: +43 1 60109 0
Fax: +43 1 60109 8312

Azerbaijan (Baku)

Tel: +994 12 404 5200
Fax: +994 12 404 5202

Bahrain (Manama)

Tel: +973 725 377
Fax: +973 725 332

Bangladesh (Dhaka)

Tel: +88 02 8856468
Fax: +88 02 8850906

Belarus (Minsk)

Tel: +375 228 12 40, 228 12 42
Fax: +375 228 12 43

Belgium (Zaventem)

Tel: +32 2 718 6320
Fax: +32 2 718 6664

Bolivia (La Paz)

Tel: +591 2 278 8181
Fax: +591 2 278 8184

Bosnia Herzegovina (Tuzla)

Tel: +387 35 246 020
Fax: +387 35 255 098

Brazil (Osasco)

Tel: 0800 014 9111
Tel: +55 11 3688 9282
Fax: +55 11 3688 9421

Bulgaria (Sofia)

Tel: +359 2 807 5500
Fax: +359 2 807 5599

Canada (Montreal)

Tel: +1 514 420 3100
Fax: +1 514 420 3138

Chile (Santiago)

Tel: +56 2 471 4391
Fax: +56 2 471 4399

China (Beijing)

Tel: +86 10 5821 7788
Fax: +86 10 5821 7618

Colombia (Bogotá)

Tel: +57 1 417 8000
Fax: +57 1 413 4086

Costa Rica (San Jose)

Tel: +506 288 5484
Fax: +506 288 5482

Croatia (Zagreb)

Tel: +385 1 600 8550
Fax: +385 1 619 5111

Czech Republic (Prague)

Tel: +420 234 322 327
e-mail: motors&drives@cz.abb.com

Denmark (Skovlunde)

Tel: +45 44 504 345
Fax: +45 44 504 365

Dominican Republic (Santo Domingo)

Tel: +809 562 9010
Fax: +809 562 9011

Ecuador (Quito)

Tel: +593 2 2500 645
Fax: +593 2 2500 650

Egypt (Cairo)

Tel: +202 2 6251630
e-mail: drives@eg.abb.com

El Salvador (San Salvador)

Tel: +503 2264 5471
Fax: +503 2264 2497

Estonia (Tallinn)

Tel: +372 6801 800
e-mail: info@ee.abb.com

Ethiopia (Addis Abeba)

Tel: +251 1 669506, 669507
Fax: +251 1 669511

Finland (Helsinki)

Tel: +358 10 22 11
Tel: +358 10 222 1999
Fax: +358 10 222 2913

France (Montluel)

Tel: +33 (0)4 37 40 40 00
Fax: +33 (0)4 37 40 40 72

Germany (Ladenburg)

Tel: +01805 222 580 (Service)
Tel: +49 (0)6203 717 717
Fax: +49 (0)6203 717 600

Greece (Athens)

Tel: +30 210 289 1 651
Fax: +30 210 289 1 792

Guatemala (Guatemala City)

Tel: +502 2 363 3814
Fax: +502 2 363 3624

Hungary (Budapest)

Tel: +36 1 443 2224
Fax: +36 1 443 2144

India (Bangalore)

Tel: +91 80 2294 9585
Fax: +91 80 2294 9389

Indonesia (Jakarta)

Tel: +62 21 2551 5555
e-mail: automation@id.abb.com

Iran (Tehran)

Tel: +98 21 2222 5120
Fax: +98 21 2222 5157

Ireland (Dublin)

Tel: +353 1 405 7300
Fax: +353 1 405 7307

Israel (Haifa)

Tel: +972 4 850 2111
Fax: +972 4 850 2112

Italy (Milan)

Tel: +39 02 2414 3085
Fax: +39 02 2414 3979

Ivory Coast (Abidjan)

Tel: +225 21 21 7575
Fax: +225 21 35 0414

Japan (Tokyo)

Tel: +81(0)3 5784 6010
Fax: +81(0)3 5784 6275

Jordan (Amman)

Tel: +962 6 562 0181
Fax: +962 6 5621369

Kazakhstan (Almaty)

Tel: +7 727 2583838
Fax: +7 727 2583839

Kenya (Nairobi)

Tel: +254 20 828811/13 to 20
Fax: +254 20 828812/21

Kuwait (Kuwait city)

Tel: +965 2428626 ext. 106
Fax: +965 2403139

Latvia (Riga)

Tel: +371 7 063 600
Fax: +371 7 063 601

Lithuania (Vilnius)

Tel: +370 5 273 8300
Fax: +370 5 273 8333

Luxembourg (Leudelange)

Tel: +352 493 116
Fax: +352 492 859

Macedonia (Skopje)

Tel: +389 23 118 010
Fax: +389 23 118 774

Malaysia (Kuala Lumpur)

Tel: +603 5628 4888
Fax: +603 5635 8200

Mauritius (Port-Louis)

Tel: +230 208 7644, 211 8624
Fax: +230 211 4077

Mexico (Mexico City)

Tel: +52 (55) 5328 1400 ext. 3008
Fax: +52 (55) 5328 7467

Morocco (Casablanca)

Tel: +212 2 234 5540
Fax: +212 2 234 2099

The Netherlands (Rotterdam)

Tel: +31 (0)10 407 8886
e-mail: freqconv@nl.abb.com

New Zealand (Auckland)

Tel: +64 9 356 2160
Fax: +64 9 357 0019

Nigeria (Ikeja, Lagos)

Tel: +234 1 4937 347
Fax: +234 1 4937 329

Norway (Oslo)

Tel: +47 03500
e-mail: motor@no.abb.com

Oman (Muscat)

Tel: +968 2456 7410
Fax: +968 2456 7406

Pakistan (Lahore)

Tel: +92 42 6315 882-85
Fax: +92 42 6368 565

Panama (Panama City)

Tel: +507 209 5400, 2095408
Fax: +507 209 5401

Peru (Lima)

Tel: +51 1 415 5100
Fax: +51 1 561 2902

The Philippines (Metro Manila)

Tel: +63 2 821 7777
Fax: +63 2 823 0309, 824 4637

Poland (Lodz)

Tel: +48 42 299 3000
Fax: +48 42 299 3340

Portugal (Oeiras)

Tel: +351 21 425 6000
Fax: +351 21 425 6390, 425 6354

Qatar (Doha)

Tel: +974 4253888
Fax: +974 4312630

Romania (Bucharest)

Tel: +40 21 310 4377
Fax: +40 21 310 4383

Russia (Moscow)

Tel: +7 495 960 22 00
Fax: +7 495 960 22 20

Saudi-Arabia (Al Khobar)

Tel: +966 (0)3 882 9394, ext. 240, 254, 247
Fax: +966 (0)3 882 4603

Senegal (Dakar)

Tel: +221 832 1242, 832 3466
Fax: +221 832 2057, 832 1239

Serbia (Belgrade)

Tel: +381 11 3094 320, 3094 300
Fax: +381 11 3094 343

Singapore (Singapore)

Tel: +65 6776 5711
Fax: +65 6778 0222

Slovakia (Banska Bystrica)

Tel: +421 48 410 2324
Fax: +421 48 410 2325

Slovenia (Ljubljana)

Tel: +386 1 2445 440
Fax: +386 1 2445 490

South Africa (Johannesburg)

Tel: +27 11 617 2000
Fax: +27 11 908 2061

South Korea (Seoul)

Tel: +82 2 528 2794
Fax: +82 2 528 2338

Spain (Barcelona)

Tel: +34 (9)3 728 8500
Fax: +34 (9)3 728 7659

Sri Lanka (Colombo)

Tel: +94 11 2399304/6
Fax: +94 11 2399303

Sweden (Västerås)

Tel: +46 (0)21 32 5000
Fax: +46 (0)21 14 8671

Switzerland (Zürich)

Tel: +41 (0)58 586 0000
Fax: +41 (0)58 586 0603

Syrian Arab Republic

Tel: +963 11 212 7018 / 9551
Fax: +963 11 212 8614

Taiwan (Taipei)

Tel: +886 2 2577 6090
Fax: +886 2 2577 9467, 2577 9434

Tanzania (Dar es Salaam)

Tel: +255 51 2136750, 2136751, 2136752
Fax: +255 51 2136749

Thailand (Bangkok)

Tel: +66 (0)2665 1000
Fax: +66 (0)2665 1042

Tunisia (Tunis)

Tel: +216 71 860 366
Fax: +216 71 860 255

Turkey (Istanbul)

Tel: +90 216 528 2200
Fax: +90 216 365 2944

Uganda (Nakasero, Kampala)

Tel: +256 41 348 800
Fax: +256 41 348 799

Ukraine (Kiev)

Tel: +380 44 495 22 11
Fax: +380 44 495 22 10

The United Arab Emirates (Dubai)

Tel: +971 4 3147500, 3401777
Fax: +971 4 3401771, 3401539

United Kingdom (Daresbury, Warrington)

Tel: +44 1925 741 111
Fax: +44 1925 741 693

Uruguay (Montevideo)

Tel: +598 2 707 7300
Tel: +598 2 707 7466

USA (New Berlin)

Tel: +1 800 752 0696
Tel: +1 262 785 3200
Fax: +1 262 785 0397

Venezuela (Caracas)

Tel: +58 212 2031949
Fax: +58 212 237 6270

Vietnam (Hochiminh)

Tel: +84 8 8237 972
Fax: +84 8 8237 970

Zimbabwe (Harare)

Tel: +263 4 369 070
Fax: +263 4 369 084

Contact us

www.abb.com/drives
www.abb.com/drivespartners

© Copyright 2009 ABB. All rights reserved.
Specifications subject to change without notice.

3AUA0000051082 REV B EN 5.6.2009. #14473